

Precision Open-Frame Power Supply OF-PSU-B-150 ± 150 V, 300 mA

Version 1.01

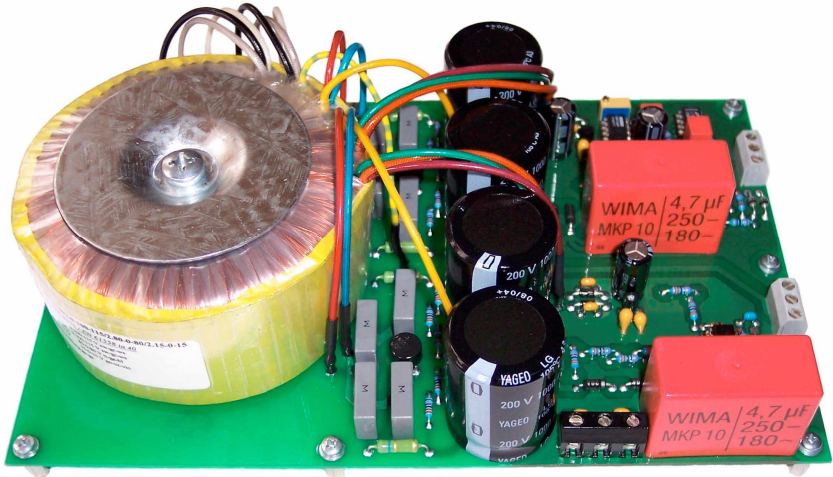

Manual

Document version 1.02, created on 05-17-2006

Contents

Technical Data	4
Characteristics.....	4
Input.....	4
Output.....	4
Power transformer	4
General.....	5
Shipment contents.....	5
Connectors	6
Fig. 1. Connecting modules of the OF-PSU-B series to the local line voltage.....	6
Fig. 2. Connectors and dimensions of the OF-PSU-B modules.....	7
Starting Up.....	8
Typical Characteristics.....	10
Fig. 3. Ripple of the positive output voltage without load.....	10
Fig. 4. Ripple of the negative output voltage without load.	10
Fig. 5. Ripple of the positive output voltage with maximum load.....	10
Fig. 6. Ripple of the negative output voltage with maximum load.....	10
Fig. 7. Low-frequency noise and drift of the positive output voltage.....	10
Fig. 8. Low-frequency noise and drift of the negative output voltage.....	10
Fig. 9. Low-frequency noise of the positive output voltage.	11
Fig. 10. Low-frequency noise of the negative output voltage.....	11
Fig. 11. Ripple and noise of both output voltages with maximum load.....	11
Fig. 12. Frequency spectrum of the output noise.....	11
Fig. 13. Transient load regulation of the positive output voltage at 67% load change.....	12
Fig. 14. Transient load regulation of the positive output voltage at 100% load change.....	12

Fig. 15. Transient load regulation of the negative output voltage at 67% load change.....	12
Fig. 16. Transient load regulation of the negative output voltage at 100% load change.....	12
Test Circuits	13
Fig. 17. Test circuit for measuring the temporal fluctuations of the output voltage (measurement of the output noise and ripple).	13
Fig. 18. Test circuit for measuring the transient load regulation.....	13
Typical Applications	14
Fig. 19. Switching the nominal value of the line voltage with a voltage selector.	14
Fig. 20. Switching the nominal value of the line voltage between 115 V and 230 V (USA/Europe) with a voltage selector.....	14

Technical Data

Characteristics

- precision linear bipolar power supply
- open frame construction
- low output noise and ripple
- short-circuit protection
- guaranteed symmetrical output voltage

Input

- voltage: 100 V, 115 V, or 230 V, $\pm 10\%$
- nominal frequency: 50 Hz
- power consumption: max. 130 VA

Output

- voltage: continuously variable from 0 to ± 165 V
(one potentiometer with 25 turns, the negative output voltage equals the positive one)
- surge protection: 150 V Transil diodes
(optimized for ± 150 V APEX amplifiers)
the nominal voltage can be changed according to customer specifications
- current: max. 300 mA, electronically limited
- minimal load: 0 mA
- asymmetry of the output voltages: $< 0.2\%$ or 1 mV, respectively
(the larger value applies)
- output ripple and noise voltage:
 $< 150 \mu\text{V}_{\text{eff}}$, $< 1.5 \text{ mV}_{\text{pp}}$ (0.1Hz – 10kHz)
- line regulation: < 5 ppm at 10% change of the line voltage
- load regulation: < 100 ppm at 100% load change
- transient load regulation: 50 μs at 50% load change
- temperature coefficient of the output voltage: < 50 ppm/K
- switch on behavior: time constant of 1.5 s

Power transformer

- Type: toroidal transformer
- Temperature protection: 120°C
- electrostatic shielding between the primary and the secondary side
- low stray field by magnetic shielding

General

- input and output connectors: clamps
- cooling: external cooler,
recommended thermal resistance ≤ 0.5 K/W
- fuses: external, recommended value: see Tab. 1
- mounting by seven M3×12 mm spacer sleeves to fix the printed circuit board and one M6 spacer sleeve to fasten the mains transformer
- dimensions: $225 \times 140 \times 70$ mm³
(length × width × height including spacer sleeves and wires)
- spacing between the mounting holes: see Fig. 2
- weight: 1.85 kg

Shipment contents

- completely assembled and tested OF-PSU-B-150 module
- materials for insulated mounting of the power transistors onto an external cooler (insulation plates, M3 screws, nuts, and washers)
- manual

Connectors

Modules of the OF-PSU-B series are equipped with 9 input and output terminals in the form of three clamps (see Fig. 2). The six input terminals (clamps CN1 and CN2) allow setting the device to operation at 100 V, 115 V, or 230 V (see Fig. 1). The stabilized output voltage is connected to the clamp CN3.

If desired, two clamps can be mounted to the printed circuit board at the positions of the power transistors T3 and T4. The transistors will then be connected to the clamps via short wires.

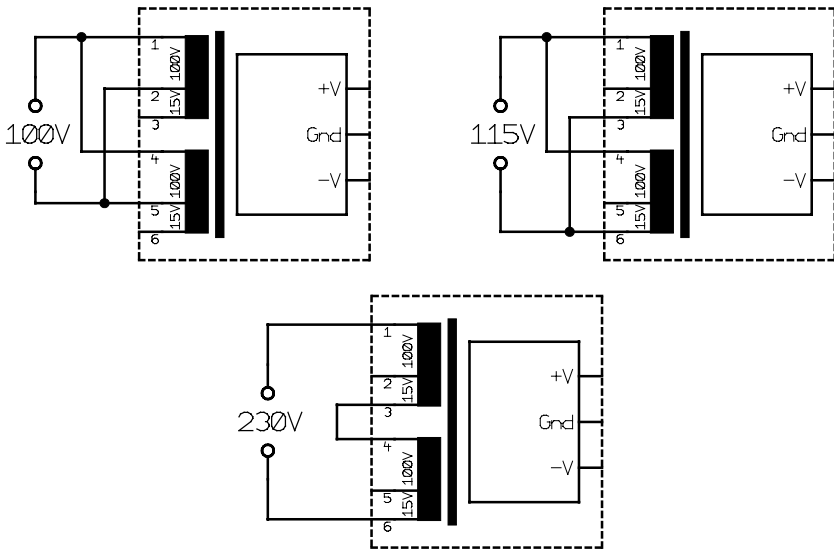

Fig. 1. Connecting modules of the OF-PSU-B series to the local line voltage.

Tab. 1. Recommended fuse values.

Nominal line voltage	Fuse
100 V	T 2.5 A
115 V	T 2 A
230 V	T 1 A

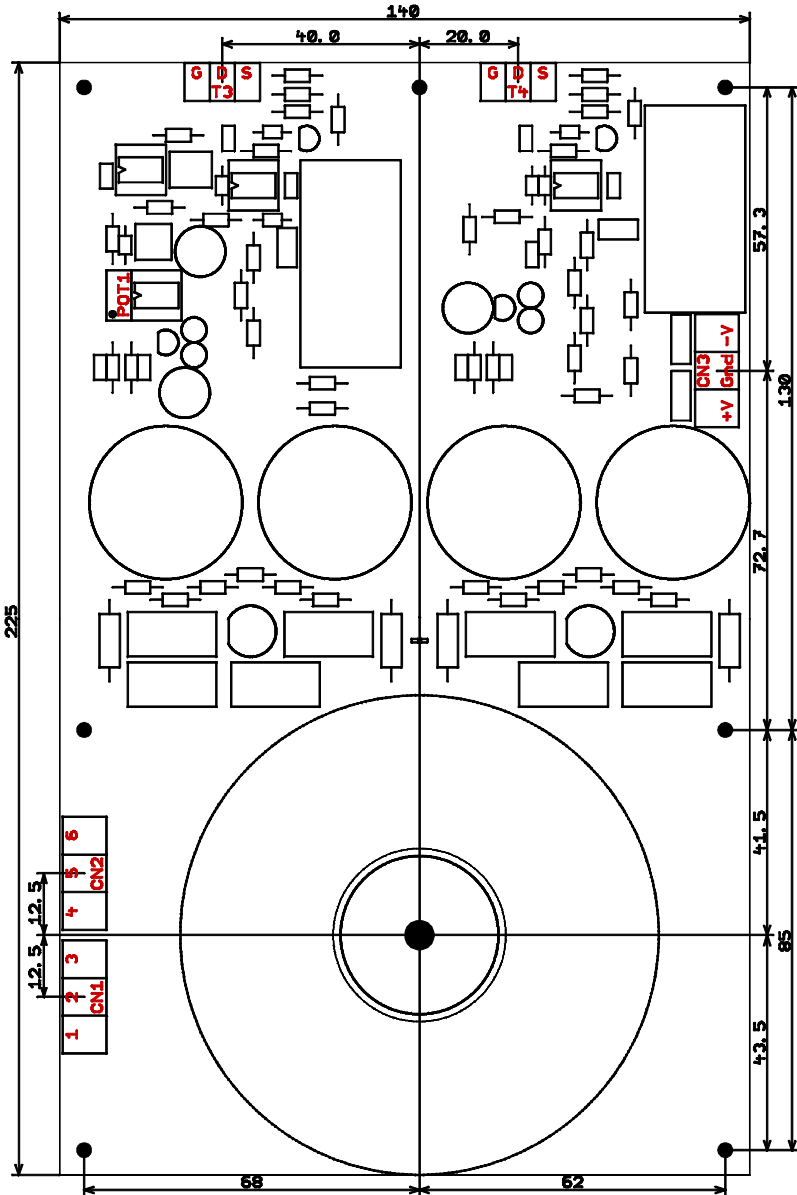

Fig. 2. Connectors and dimensions of the OF-PSU-B modules. CN1, CN2: line input, CN3: output, POT1: potentiometer for regulation of the output voltage, T3, T4: power transistors. Dimensions are given in mm.

Starting Up

Modules of the OF-PSU-B series may be used only with an external heat sink. Before starting up, the module must be mechanically fixed and the power transistors (T3 and T4 in Fig. 2) must be mounted onto an appropriate heat sink with the parts provided with the module. The heat sink must be large enough to be able to dissipate the maximum power loss of the transistor of about 120 W that can occur in the event of a short circuit at both outputs.

The modules are intended to be mounted in a metal housing, with an extruded heat sink on the rear wall. It is important to ensure that all the components on the circuit board, as well as all its conducting tracks, are sufficiently separated from other conducting objects. In addition, the mounting of the power transistors should be tested for possible short circuits to the heat sink. The spacer sleeves of the modules are installed insulated, and thus can be connected galvanically to the housing.

To minimize the ripple and noise of the output voltage, the module should be directly mounted on a grounded metallic plate. Further, the module should be protected from strong external stray fields (e.g., from magnetically unshielded transformers, switching power supplies, unshielded lines, etc.).

Depending on the nominal line voltage, the power cable has to be mounted to the clamps CN1 and CN2 (see Fig. 1). To set the device for the nominal line voltage, a voltage selector can be installed (see Fig. 19 and Fig. 20). Modules of the OF-PSU-B series are intended for use in complex devices and therefore do not themselves contain a line fuse. However, the complete device must be equipped with an appropriate fuse (see Tab. 1).

! **Caution:** For safety reasons, using the modules without a properly rated fuse is expressly forbidden.

After switching on the line voltage, the actual output voltage can be set with the potentiometer POT1 (see Fig. 2). During the adjustment, the time constant of the reference circuit of 1.5 seconds must be taken into account. The potentiometer directly controls the positive output voltage; the negative voltage is internally derived from the positive one, and thus does not require any adjustments.

- !** **Caution:** Only schooled personnel may work with this device without a grounded housing. Setting the output voltage (POT1 in Fig. 2) may only be done with insulated tools. There may be high voltage remaining on the capacitors several minutes after the module is shut down.
- !** Modules of the OF-PSU-B series are intended for supplying APEX high-voltage amplifiers. They are equipped with surge diodes that offer optimal protection for these amplifiers (see "Technical Data"). While starting up with the power supplies, the threshold voltage of the surge diodes must be taken into account and ***the output voltage must not exceed this value.*** Neglecting this can destroy the surge diodes, and thus the whole module.

Typical Characteristics

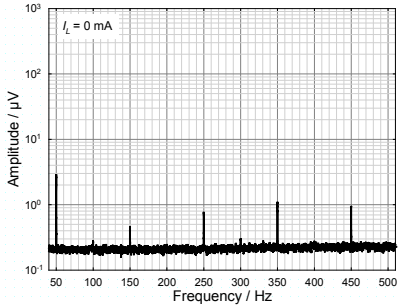

Fig. 3. Ripple of the positive output voltage without load.

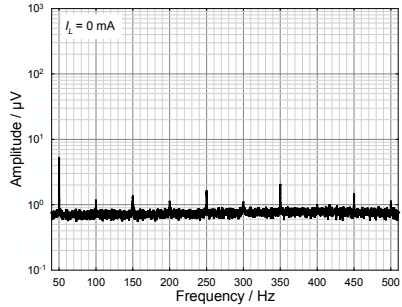

Fig. 4. Ripple of the negative output voltage without load.

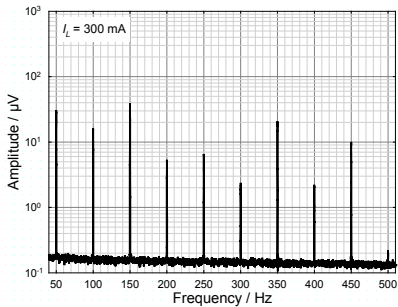

Fig. 5. Ripple of the positive output voltage with maximum load.

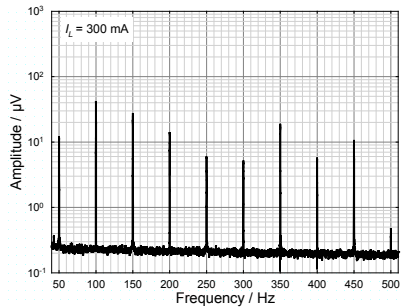

Fig. 6. Ripple of the negative output voltage with maximum load.

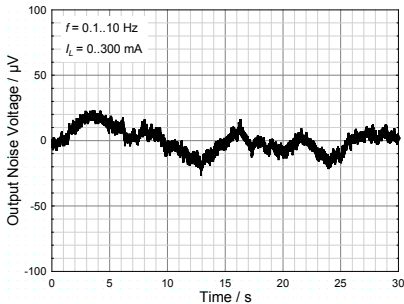

Fig. 7. Low-frequency noise and drift of the positive output voltage.

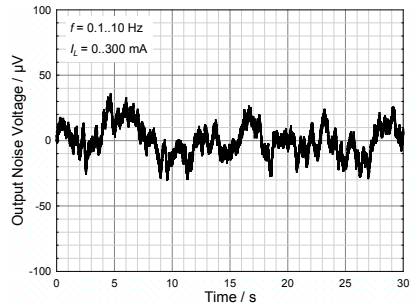

Fig. 8. Low-frequency noise and drift of the negative output voltage.

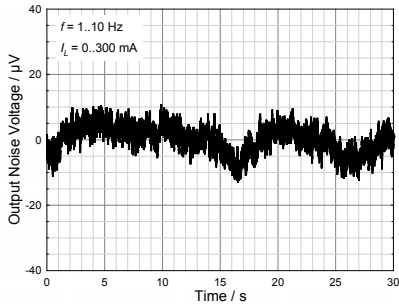

Fig. 9. Low-frequency noise of the positive output voltage.

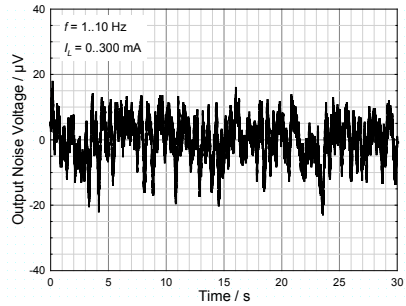

Fig. 10. Low-frequency noise of the negative output voltage.

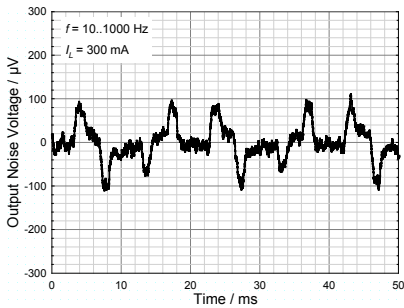

Fig. 11. Ripple and noise of both output voltages with maximum load.

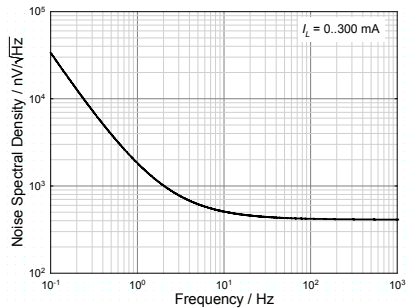

Fig. 12. Frequency spectrum of the output noise.

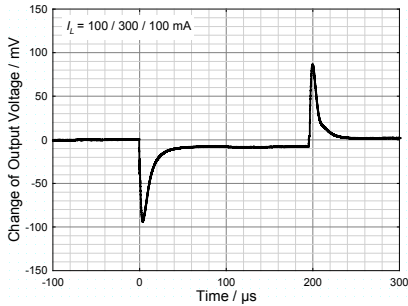

Fig. 13. Transient load regulation of the positive output voltage at 67% load change.

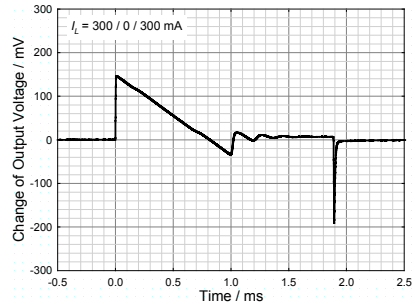

Fig. 14. Transient load regulation of the positive output voltage at 100% load change.

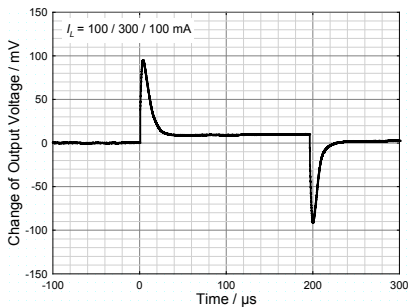

Fig. 15. Transient load regulation of the negative output voltage at 67% load change.

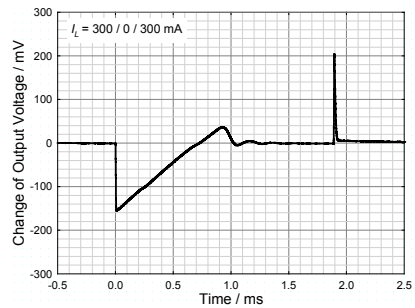

Fig. 16. Transient load regulation of the negative output voltage at 100% load change.

Comment: The module was electrostatically screened for the measurement of the output ripple voltage.

Test Circuits

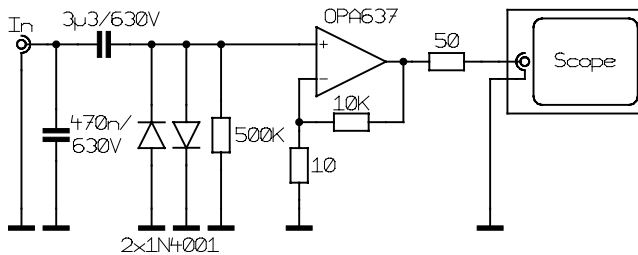

Fig. 17. Test circuit for measuring the temporal fluctuations of the output voltage (measurement of the output noise and ripple).

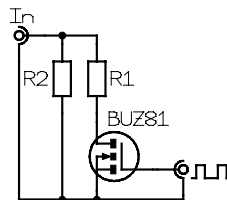

Fig. 18. Test circuit for measuring the transient load regulation.

Typical Applications

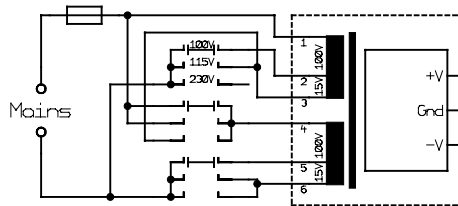

Fig. 19. Switching the nominal value of the line voltage with a voltage selector.

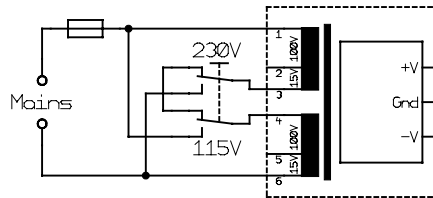

Fig. 20. Switching the nominal value of the line voltage between 115 V and 230 V (USA/Europe) with a voltage selector.